

PLAN

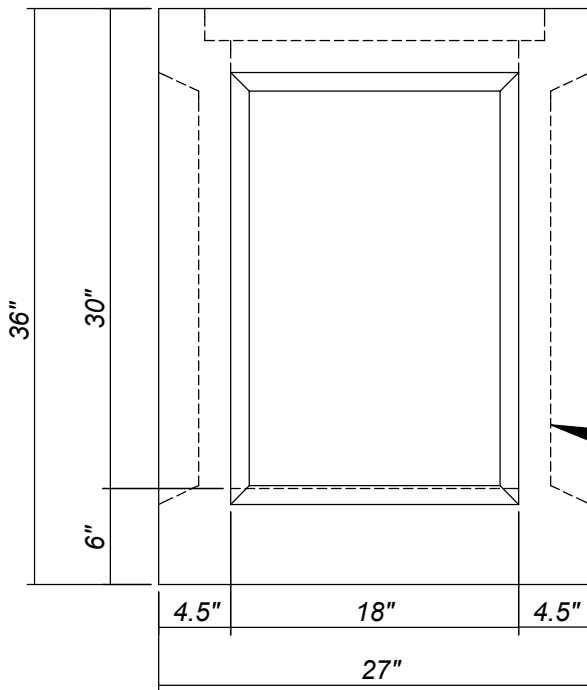

ELEVATION

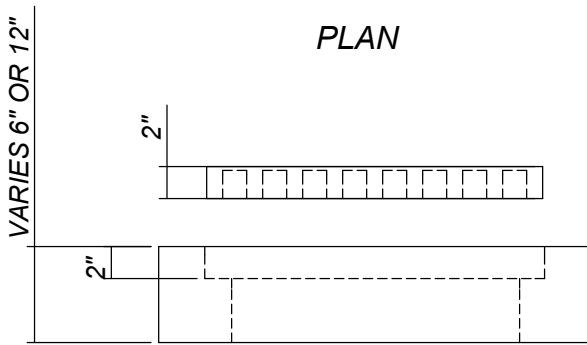
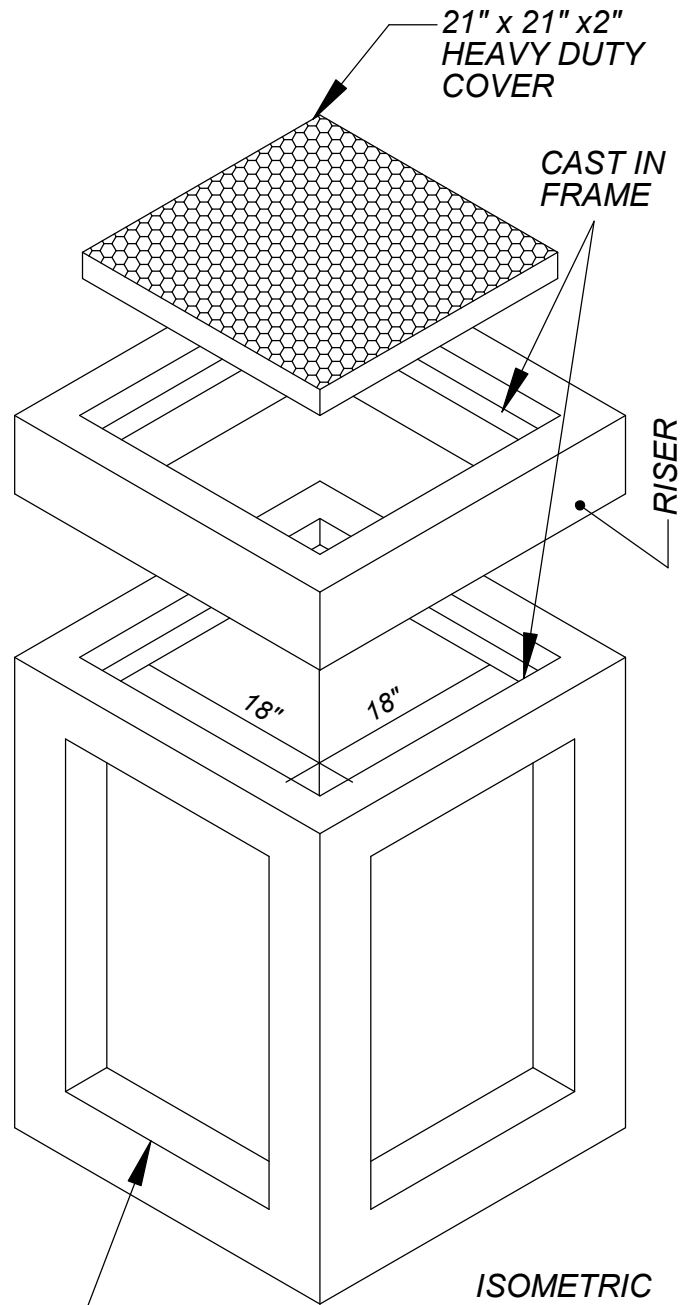

ISOMETRIC

THIN WALL KNOCK OUTS FOR 12" R.C.P. TYPICAL ALL WALLS

NOTE: GRADE 60 REINFORCEMENT
4500 PSI CONCRETE
H 20 LOADING